

BGP Attributes and Path Selection



ISP Workshops

BGP Attributes



The “tools” available for the job

What Is an Attribute?

...	Next Hop	AS Path	MED
-----	----------	---------	-----	-----	-----

- ❑ Part of a BGP Update
- ❑ Describes the characteristics of prefix
- ❑ Can either be transitive or non-transitive
- ❑ Some are mandatory

AS-Path

- ❑ Sequence of ASes a route has traversed
- ❑ Mandatory transitive attribute
- ❑ Used for:
 - Loop detection
 - Applying policy

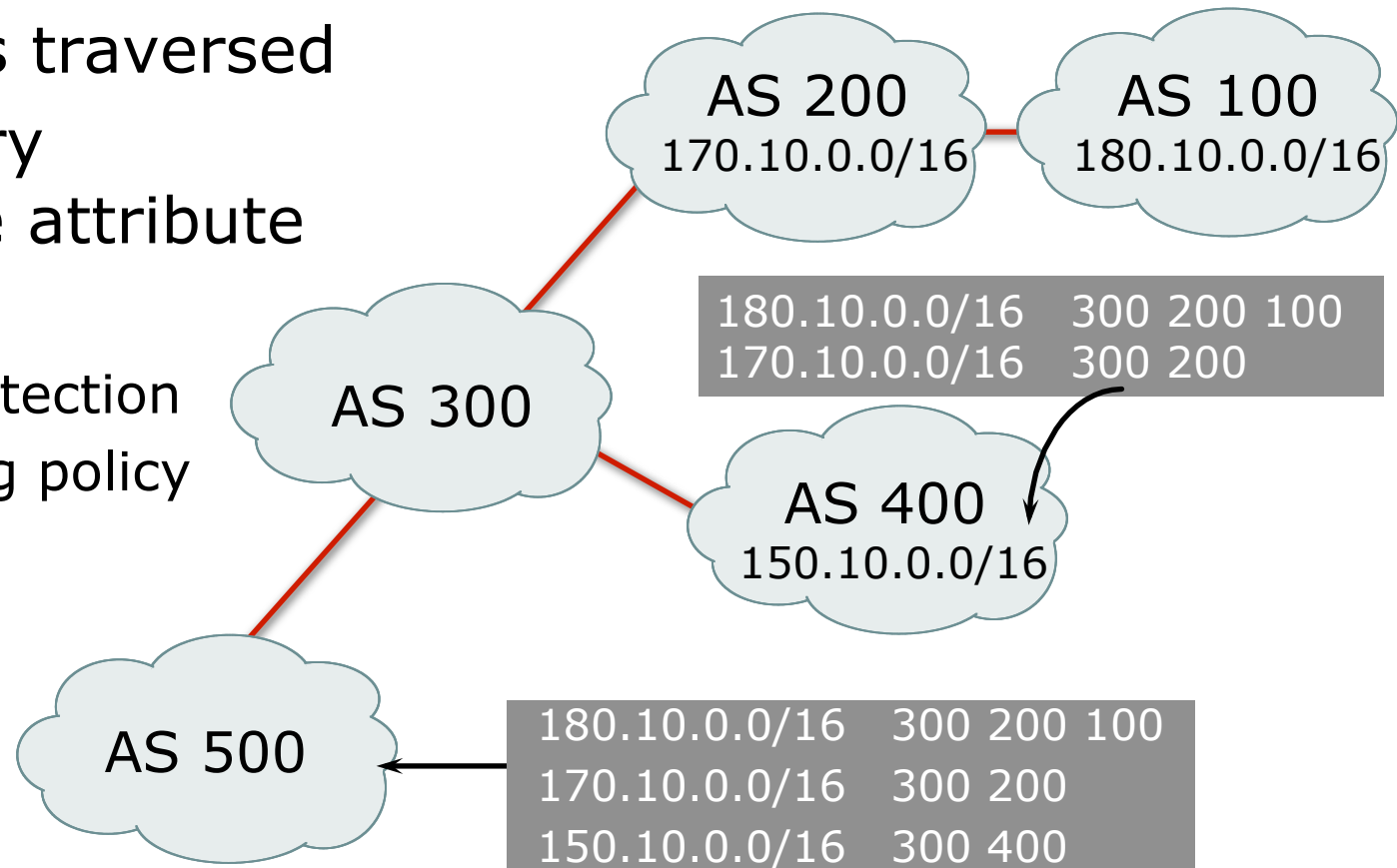

AS-Path (with 16 and 32-bit ASNs)

- ❑ Internet with 16-bit and 32-bit ASNs
 - 32-bit ASNs are 65536 and above
- ❑ AS-PATH length maintained

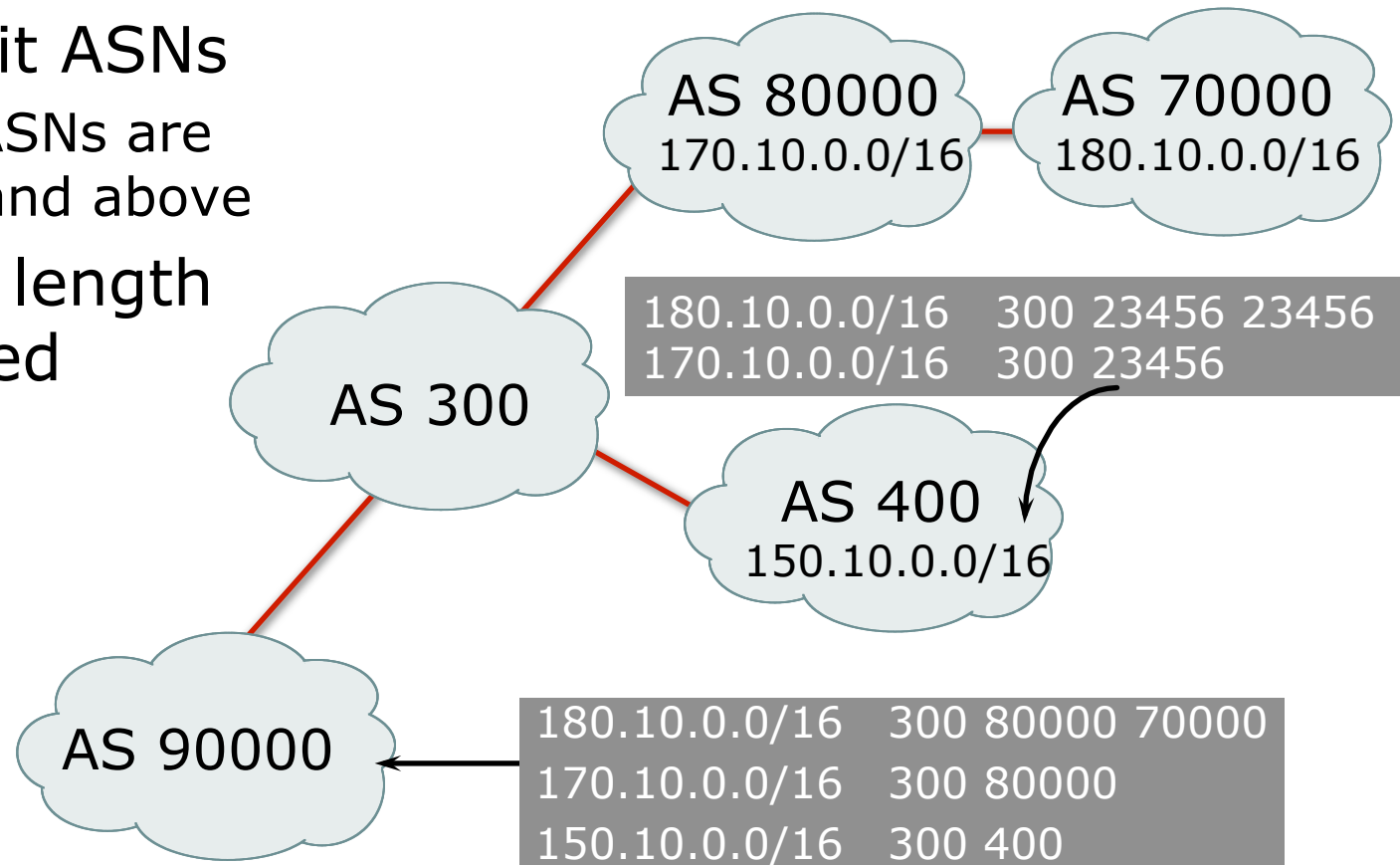

AS-Path loop detection

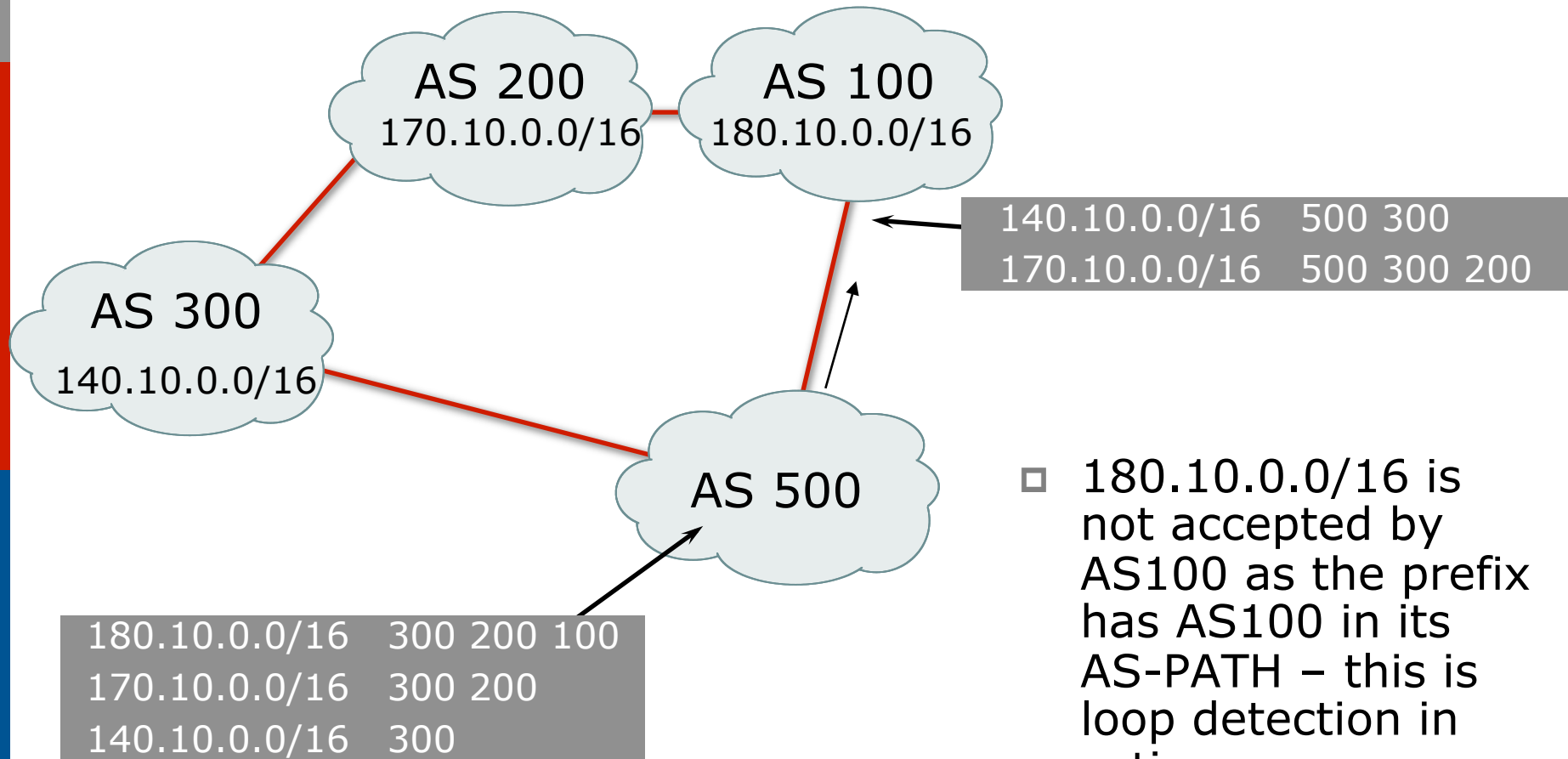

Next Hop

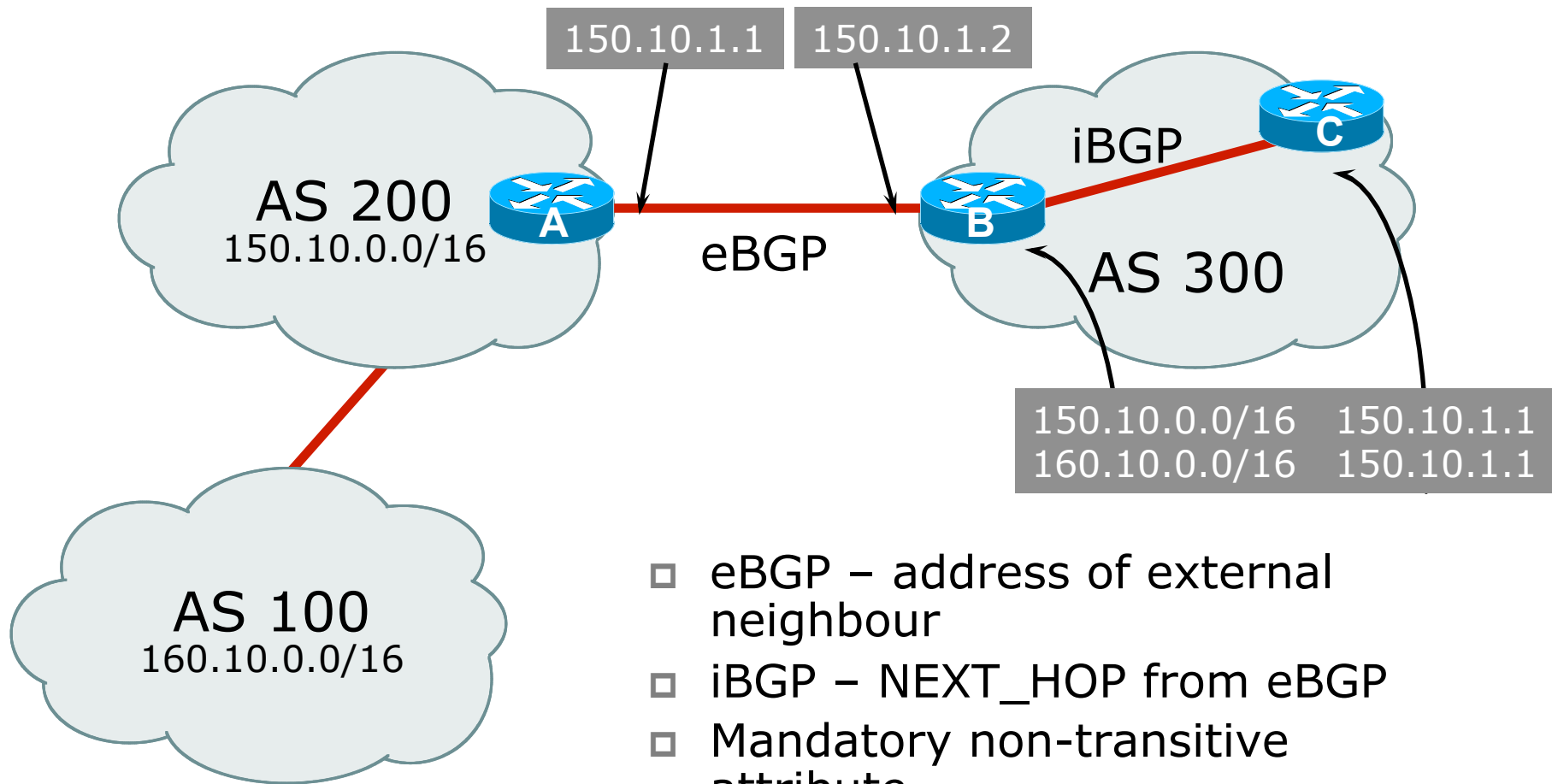

- ❑ eBGP – address of external neighbour
- ❑ iBGP – NEXT_HOP from eBGP
- ❑ Mandatory non-transitive attribute

iBGP Next Hop

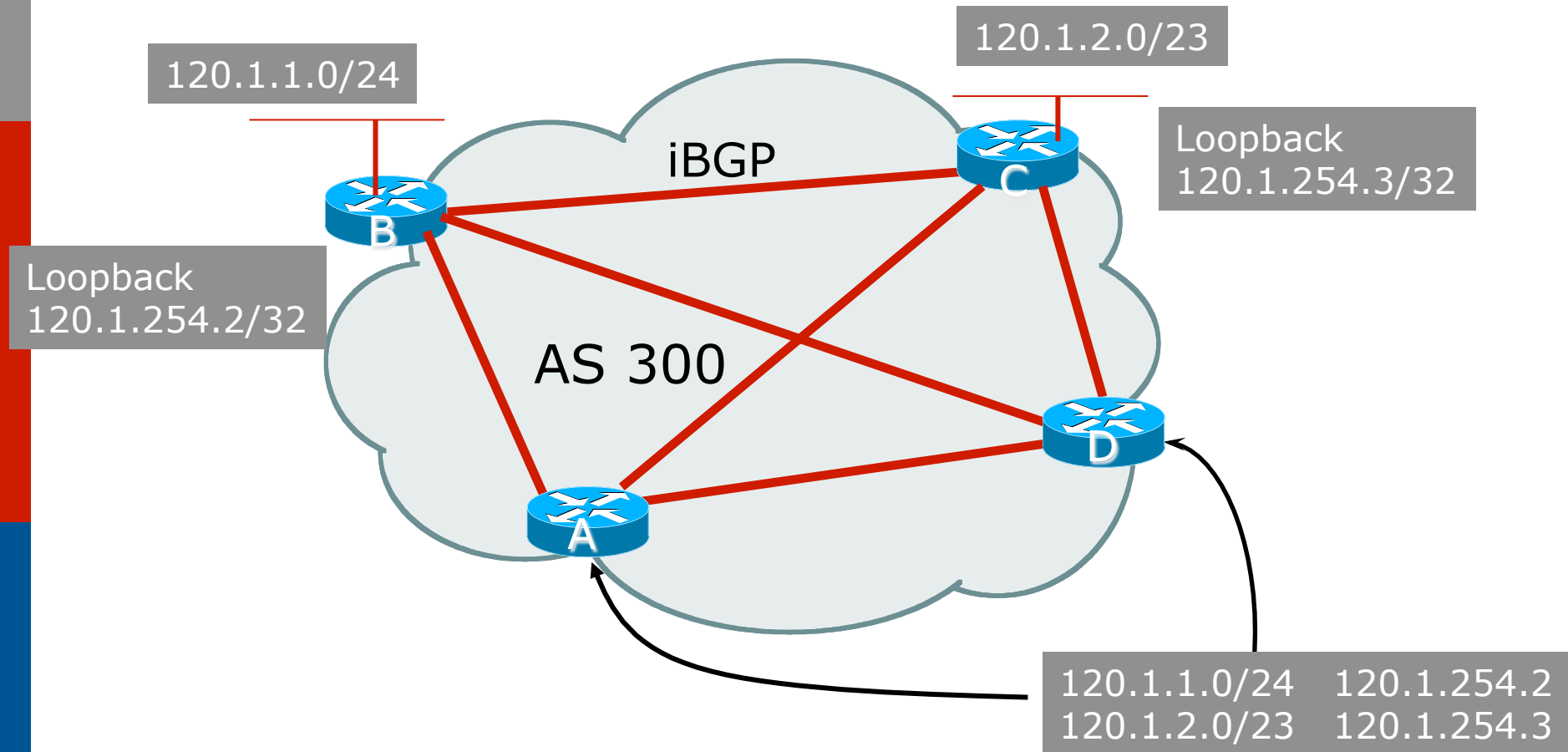

- ❑ Next hop is ibgp router loopback address
- ❑ Recursive route look-up

Third Party Next Hop

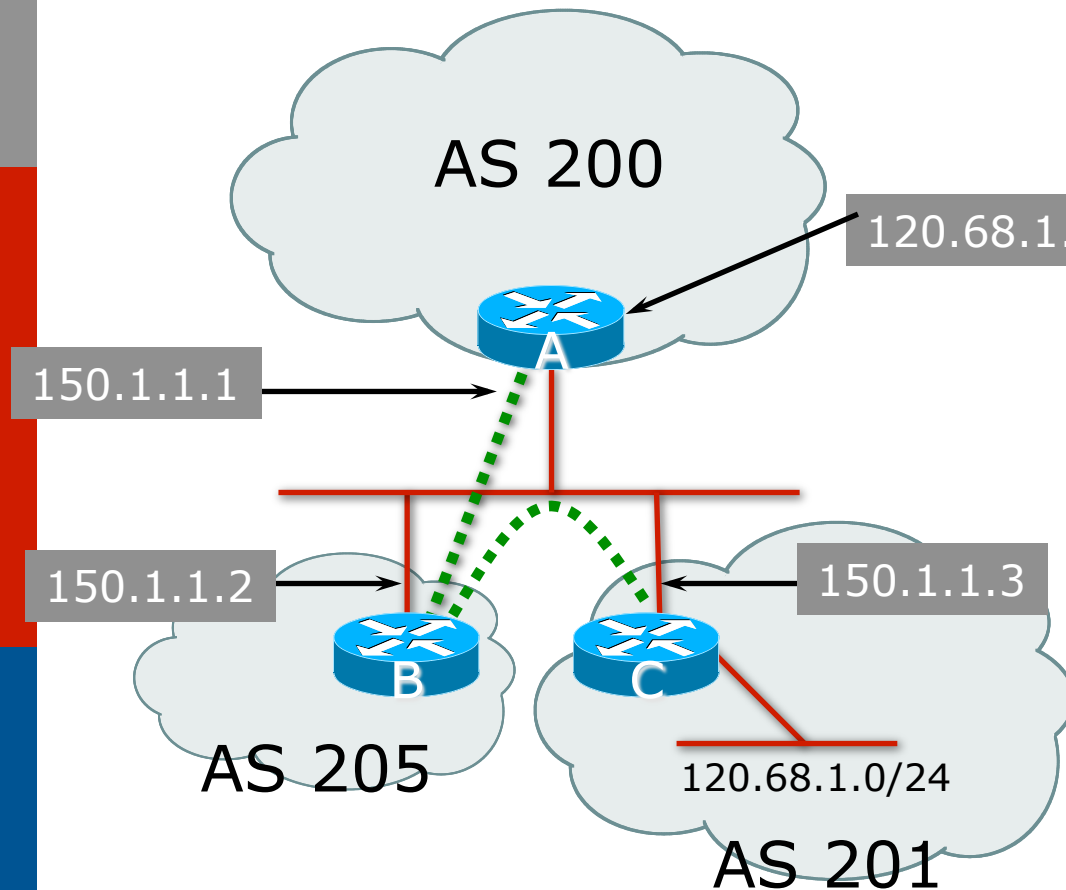

- ❑ eBGP between Router A and Router B
- ❑ eBGP between Router B and Router C
- ❑ 120.68.1/24 prefix has next hop address of 150.1.1.3 – this is used by Router A instead of 150.1.1.2 as it is on same subnet as Router B
- ❑ More efficient
- ❑ No extra config needed⁹

Next Hop Best Practice

- ❑ Cisco IOS default is for external next-hop to be propagated unchanged to iBGP peers
 - This means that IGP has to carry external next-hops
 - Forgetting means external network is invisible
 - With many eBGP peers, it is unnecessary extra load on IGP
- ❑ ISP Best Practice is to change external next-hop to be that of the local router

```
neighbor x.x.x.x next-hop-self
```

Next Hop (Summary)

- ❑ IGP should carry route to next hops
- ❑ Recursive route look-up
- ❑ Unlinks BGP from actual physical topology
- ❑ Use “next-hop-self” for external next hops
- ❑ Allows IGP to make intelligent forwarding decision

Origin

- ❑ Conveys the origin of the prefix
- ❑ **Historical** attribute
 - Used in transition from EGP to BGP
- ❑ Transitive and Mandatory Attribute
- ❑ Influences best path selection
- ❑ Three values: IGP, EGP, incomplete
 - IGP – generated by BGP network statement
 - EGP – generated by EGP
 - incomplete – redistributed from another routing protocol

Aggregator

- ❑ Conveys the IP address of the router or BGP speaker generating the aggregate route
- ❑ Optional & transitive attribute
- ❑ Useful for debugging purposes
- ❑ Does not influence best path selection
- ❑ Creating aggregate using “aggregate-address” sets the aggregator attribute:

```
router bgp 100
  aggregate-address 100.1.0.0 255.255.0.0
```

Local Preference

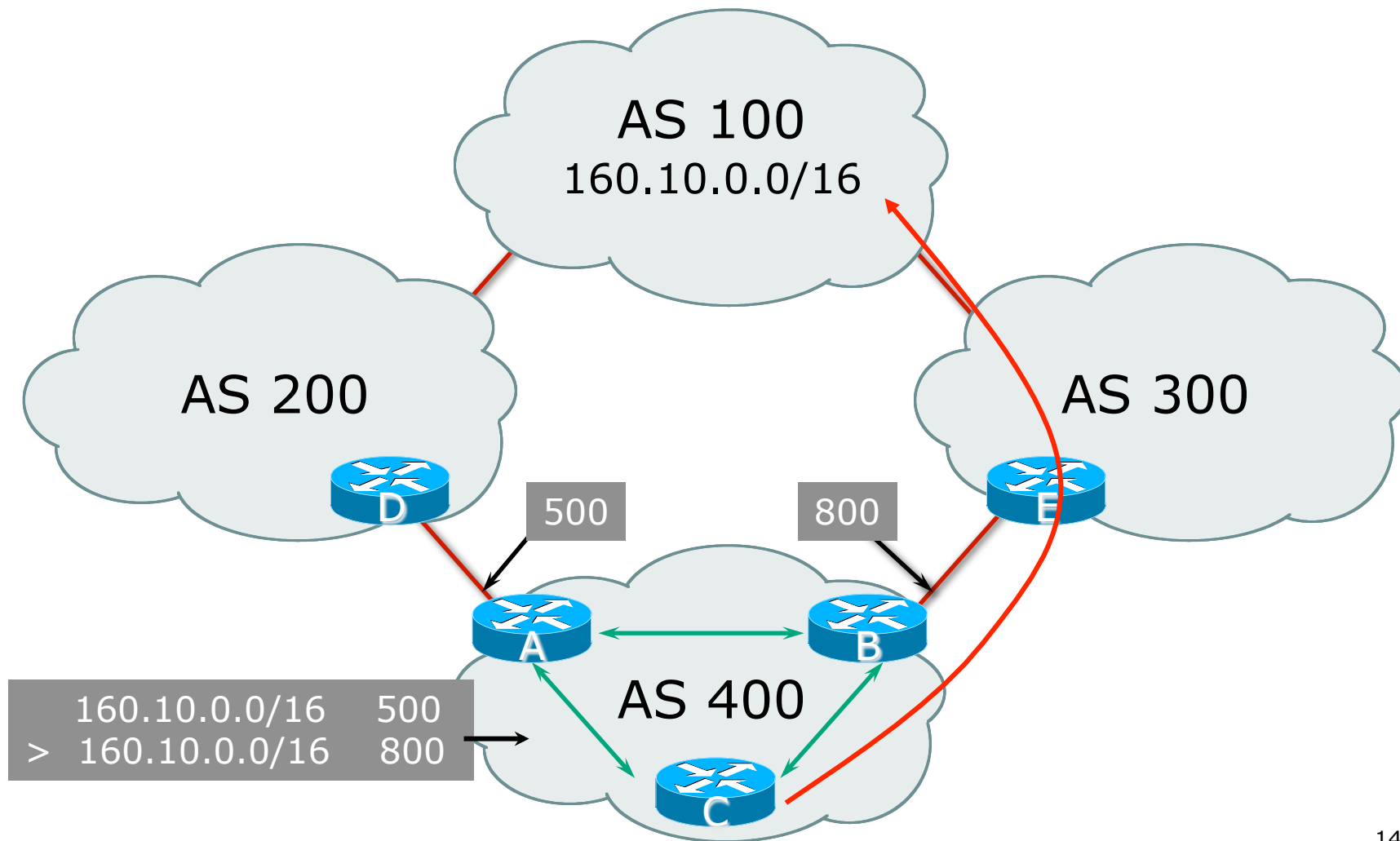

Local Preference

- Non-transitive and optional attribute
- Local to an AS only
 - Default local preference is 100 (IOS)
- Used to influence BGP path selection
 - determines best path for *outbound* traffic
- Path with highest local preference wins

Local Preference

□ Configuration of Router B:

```
router bgp 400
  neighbor 120.5.1.1 remote-as 300
  neighbor 120.5.1.1 route-map LOCAL-PREF in
!
route-map LOCAL-PREF permit 10
  match ip address prefix-list MATCH
  set local-preference 800
route-map LOCAL-PREF permit 20
!
ip prefix-list MATCH permit 160.10.0.0/16
```

Multi-Exit Discriminator (MED)

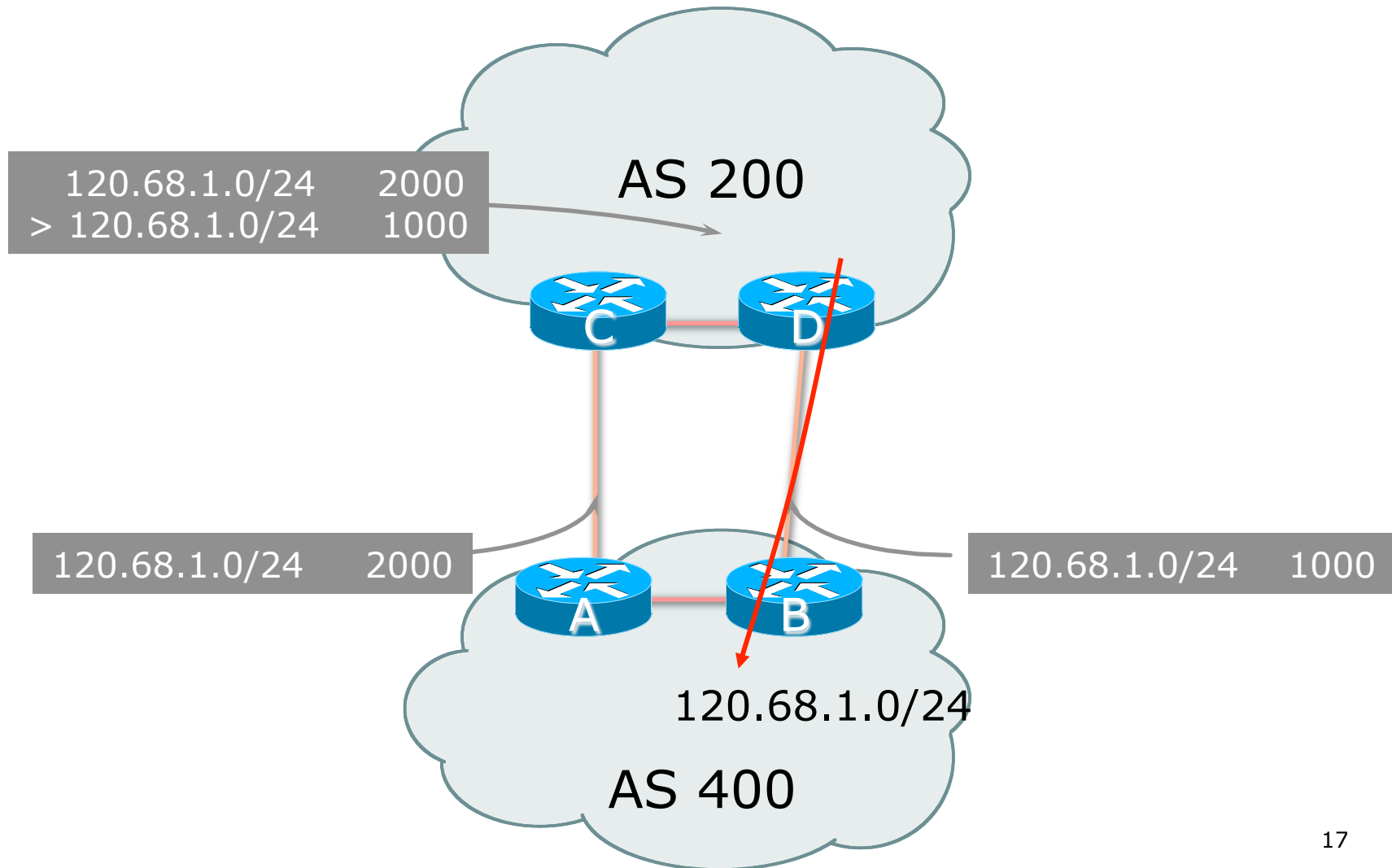

Multi-Exit Discriminator

- ❑ Inter-AS – non-transitive & optional attribute
- ❑ Used to convey the relative preference of entry points
 - determines best path for inbound traffic
- ❑ Comparable if paths are from same AS
 - `bgp always-compare-med` allows comparisons of MEDs from different ASes
- ❑ Path with lowest MED wins
- ❑ Absence of MED attribute implies MED value of **zero** (RFC4271)

Deterministic MED

- ❑ IOS compares paths in the order they were received
 - Leads to inconsistent decisions when comparing MED
- ❑ Deterministic MED
 - Configure on all bgp speaking routers in AS
 - Orders paths according to their neighbouring ASN
 - Best path for each neighbour ASN group is selected
 - Overall bestpath selected from the winners of each group

```
router bgp 100
  bgp deterministic-med
```

MED & IGP Metric

- IGP metric can be conveyed as MED
 - `set metric-type internal` in route-map
 - enables BGP to advertise a MED which corresponds to the IGP metric values
 - changes are monitored (and re-advertised if needed) every 600s
 - `bgp dynamic-med-interval <secs>`

Multi-Exit Discriminator

□ Configuration of Router B:

```
router bgp 400
  neighbor 120.5.1.1 remote-as 200
  neighbor 120.5.1.1 route-map SET-MED out
!
route-map SET-MED permit 10
  match ip address prefix-list MATCH
  set metric 1000
route-map SET-MED permit 20
!
ip prefix-list MATCH permit 120.68.1.0/24
```

Weight

- ❑ Not really an attribute – local to router
- ❑ Highest weight wins
- ❑ Applied to all routes from a neighbour

```
neighbor 120.5.7.1 weight 100
```

- ❑ Weight assigned to routes based on filter

```
neighbor 120.5.7.3 filter-list 3 weight 50
```

Weight – Used to help Deploy RPF

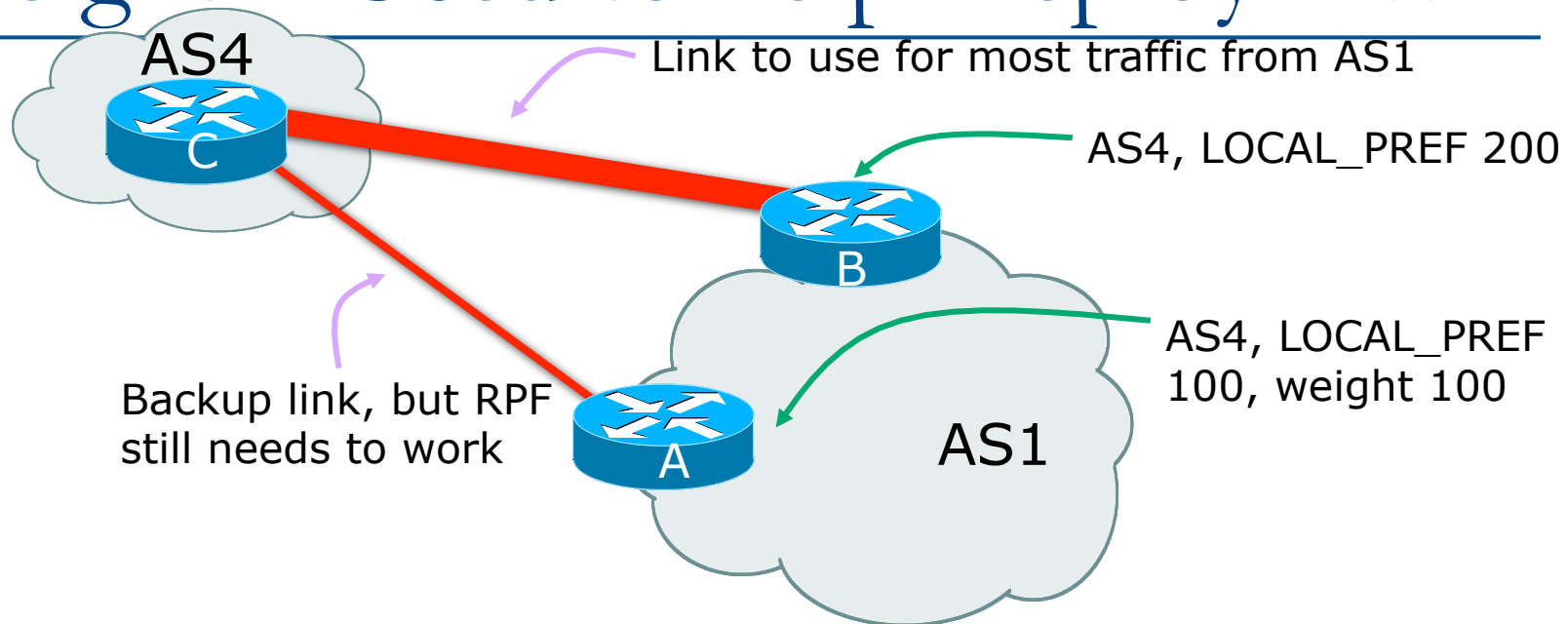

- ❑ Best path to AS4 from AS1 is always via B due to local-pref
- ❑ But packets arriving at A from AS4 over the direct C to A link will pass the RPF check as that path has a priority due to the weight being set
 - If weight was not set, best path back to AS4 would be via B, and the RPF check would fail

Aside: What is uRPF?

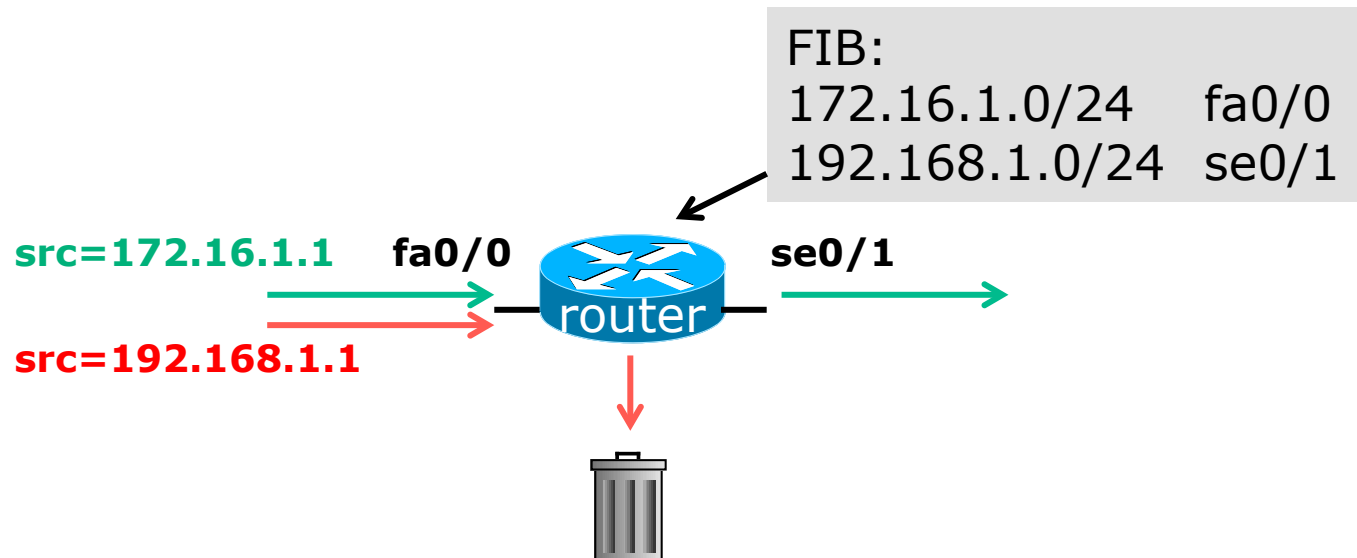

- Router compares source address of incoming packet with FIB entry
 - If FIB entry interface matches incoming interface, the packet is forwarded
 - If FIB entry interface does not match incoming interface, the packet is dropped

Weight – Used for traffic policy

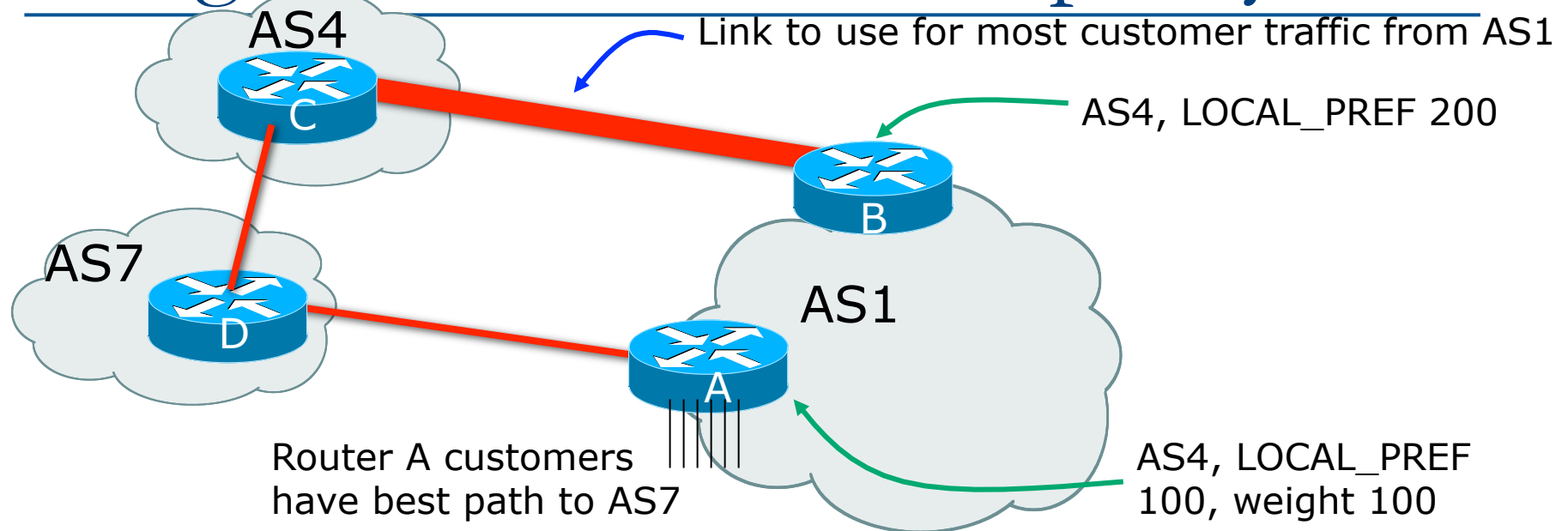

- ❑ Best path to AS4 from AS1 is always via B due to local-pref
- ❑ But customers connected directly to Router A use the link to AS7 as best outbound path because of the high weight applied to routes heard from AS7
 - If the A to D link goes down, then the Router A customers see best path via Router B and AS4

Community

- Communities are described in RFC1997
 - Transitive and Optional Attribute
- 32 bit integer
 - Represented as two 16 bit integers (RFC1998)
 - Common format is <local-ASN>:xx
 - 0:0 to 0:65535 and 65535:0 to 65535:65535 are reserved
- Used to group destinations
 - Each destination could be member of multiple communities
- Very useful in applying policies within and between ASes

Community Example (before)

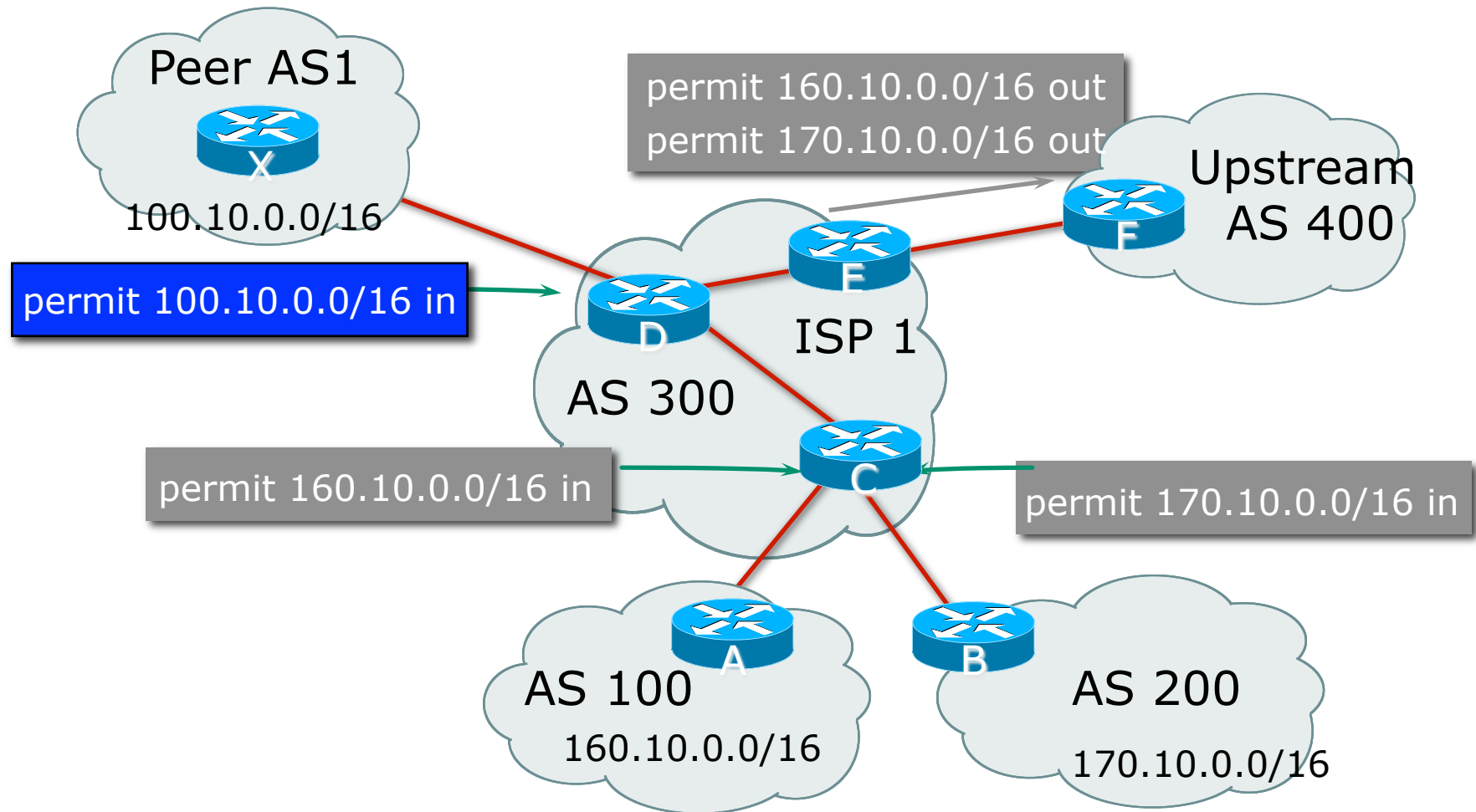

Community Example (after)

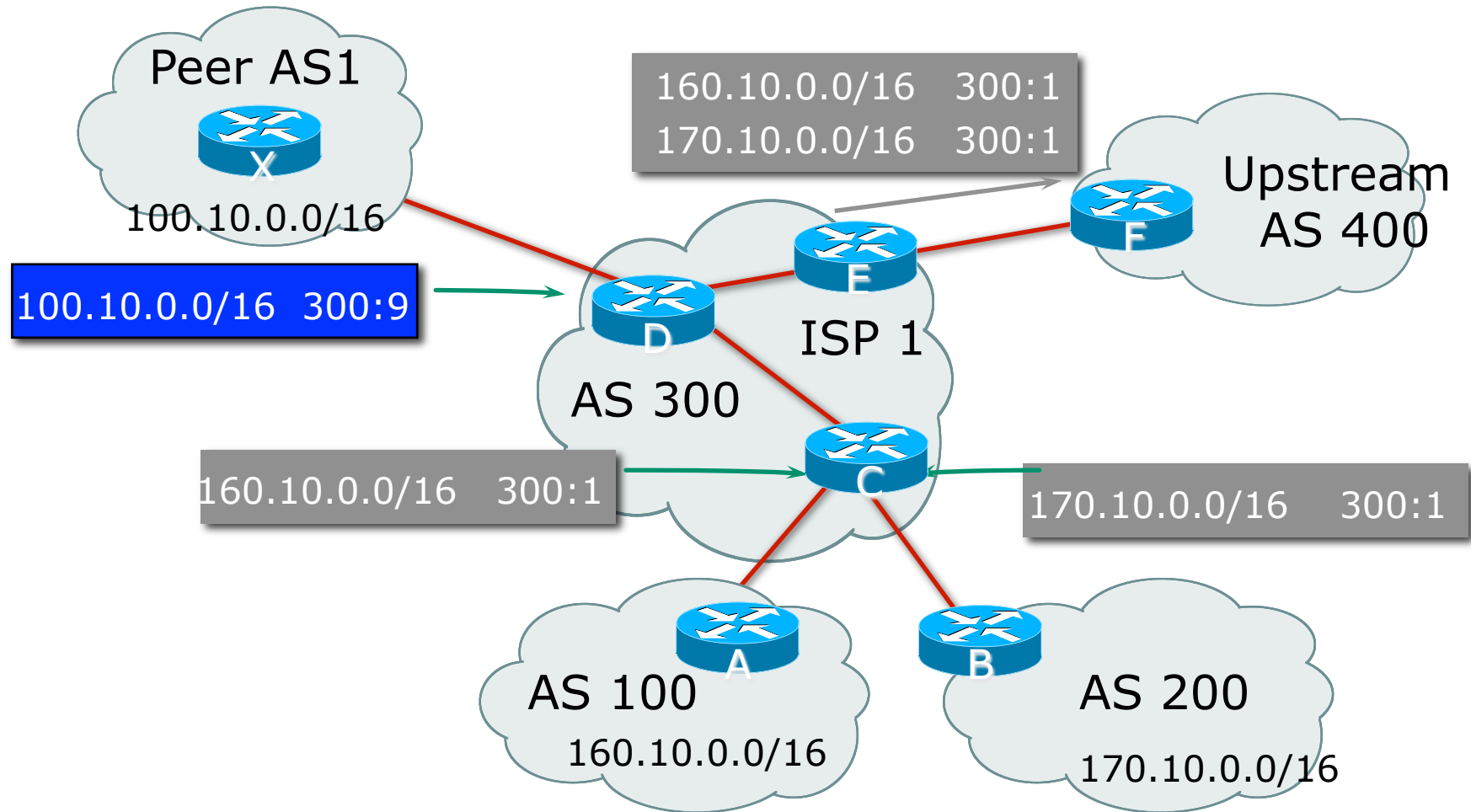

Well-Known Communities

- ❑ Several well known communities
 - www.iana.org/assignments/bgp-well-known-communities
- ❑ no-export 65535:65281
 - do not advertise to any eBGP peers
- ❑ no-advertise 65535:65282
 - do not advertise to any BGP peer
- ❑ no-export-subconfed 65535:65283
 - do not advertise outside local AS (only used with confederations)
- ❑ no-peer 65535:65284
 - do not advertise to bi-lateral peers (RFC3765)

No-Export Community

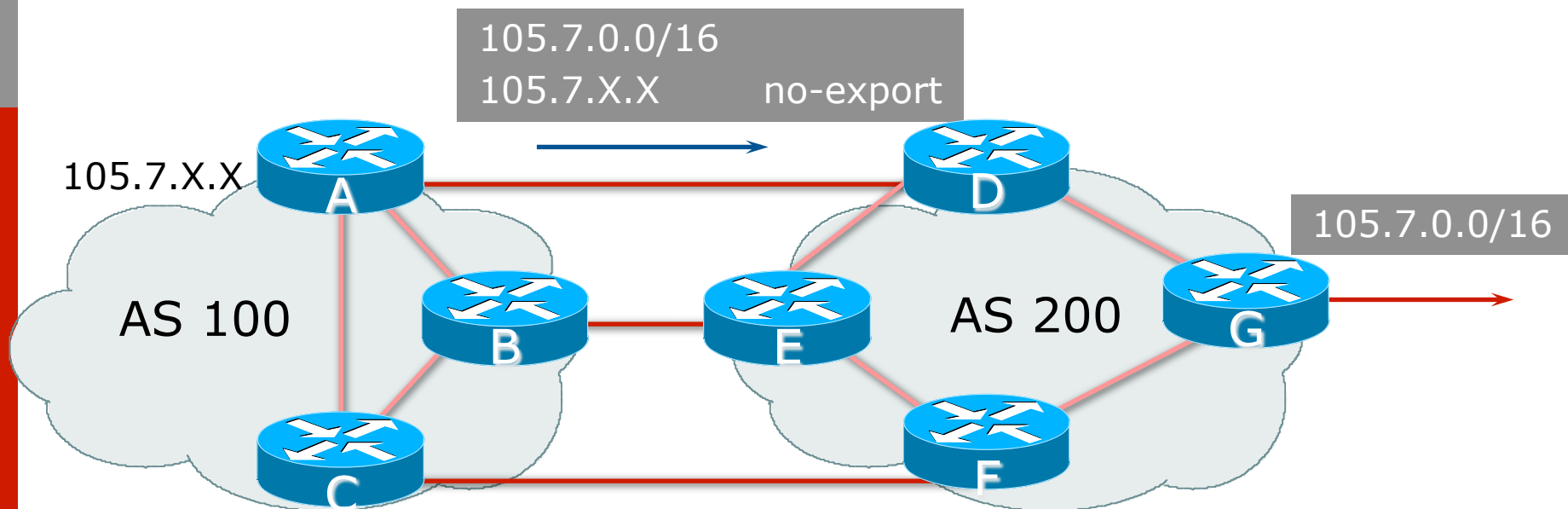

- ❑ AS100 announces aggregate and subprefixes
 - Intention is to improve loadsharing by leaking subprefixes
- ❑ Subprefixes marked with **no-export** community
- ❑ Router G in AS200 does not announce prefixes with **no-export** community set

No-Peer Community

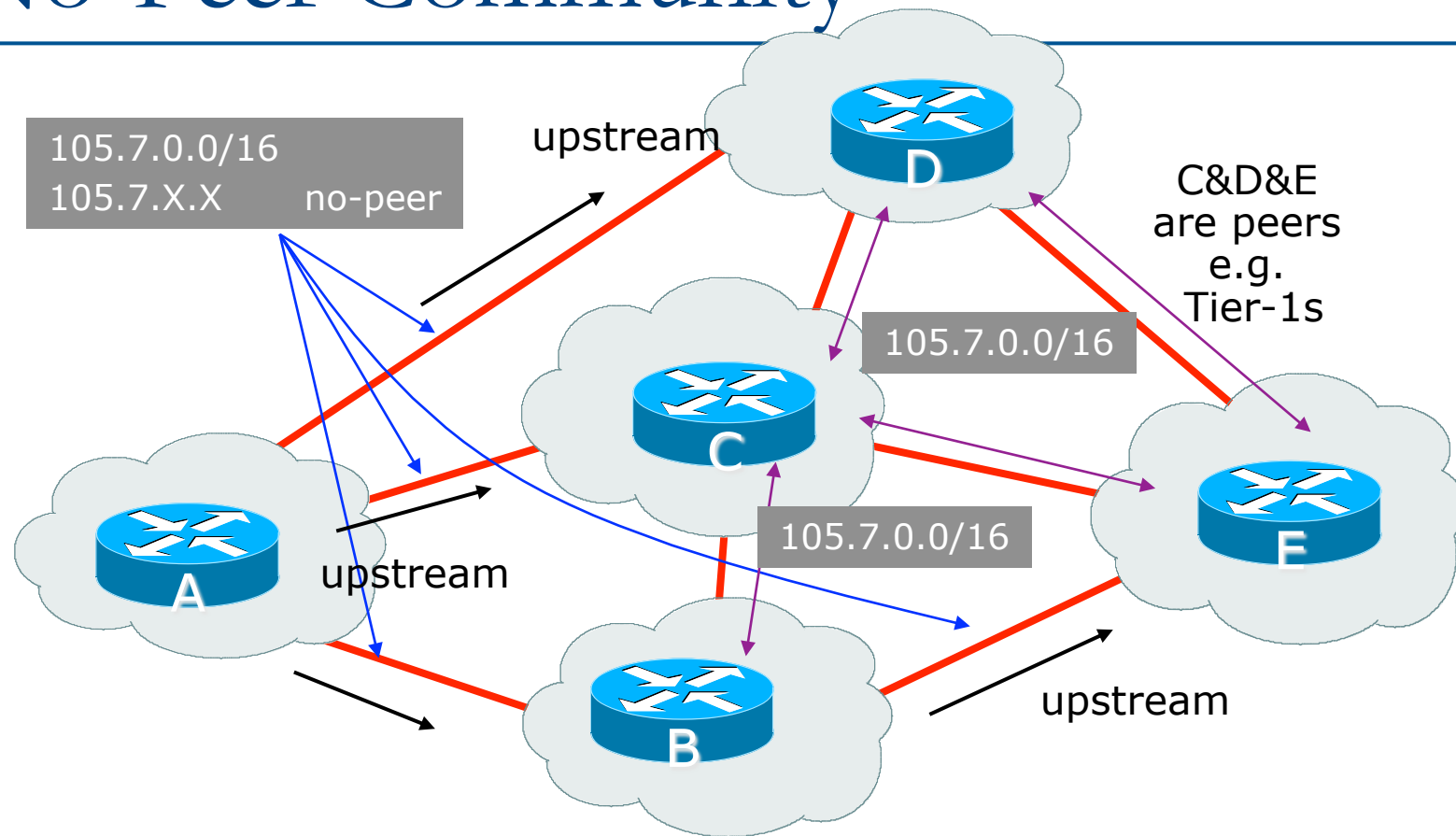

- Sub-prefixes marked with **no-peer** community are not sent to bi-lateral peers
 - They are only sent to upstream providers

What about 4-byte ASNs?

- ❑ Communities are widely used for encoding ISP routing policy
 - 32 bit attribute
- ❑ RFC1998 format is now “standard” practice
 - ASN:number
- ❑ Fine for 2-byte ASNs, but 4-byte ASNs cannot be encoded
- ❑ Solutions:
 - Use “private ASN” for the first 16 bits
 - Wait for <http://datatracker.ietf.org/doc/draft-ietf-idr-as4octet-extcomm-generic-subtype/> to be implemented

Summary

Attributes in Action

```
Router6>sh ip bgp
```

```
BGP table version is 16, local router ID is 10.0.15.246
```

```
Status codes: s suppressed, d damped, h history, * valid, > best, i - internal,  
r RIB-failure, S Stale, m multipath, b backup-path, f RT-Filter,  
x best-external, a additional-path, c RIB-compressed,
```

```
Origin codes: i - IGP, e - EGP, ? - incomplete
```

```
RPKI validation codes: V valid, I invalid, N Not found
```

	Network	Next Hop	Metric	LocPrf	Weight	Path
*>i	10.0.0.0/26	10.0.15.241	0	100	0	i
*>i	10.0.0.64/26	10.0.15.242	0	100	0	i
*>i	10.0.0.128/26	10.0.15.243	0	100	0	i
*>i	10.0.0.192/26	10.0.15.244	0	100	0	i
*>i	10.0.1.0/26	10.0.15.245	0	100	0	i
*>	10.0.1.64/26	0.0.0.0	0		32768	i
*>i	10.0.1.128/26	10.0.15.247	0	100	0	i
*>i	10.0.1.192/26	10.0.15.248	0	100	0	i
*>i	10.0.2.0/26	10.0.15.249	0	100	0	i
*>i	10.0.2.64/26	10.0.15.250	0	100	0	i

```
...
```

BGP Path Selection Algorithm



Why is this the best path?

BGP Path Selection Algorithm for Cisco IOS: Part One

1. Do not consider path if no route to next hop
2. Do not consider iBGP path if not synchronised (Cisco IOS)
3. Highest weight (local to router)
4. Highest local preference (global within AS)
5. Prefer locally originated route
6. Shortest AS path

BGP Path Selection Algorithm for Cisco IOS: Part Two

7. Lowest origin code
 - IGP < EGP < incomplete
8. Lowest Multi-Exit Discriminator (MED)
 - If **bgp deterministic-med**, order the paths by AS number before comparing
 - If **bgp always-compare-med**, then compare for all paths
 - Otherwise MED only considered if paths are from the same AS (default)

BGP Path Selection Algorithm for Cisco IOS: Part Three

9. Prefer eBGP path over iBGP path
10. Path with lowest IGP metric to next-hop
11. For eBGP paths:
 - If multipath is enabled, install N parallel paths in forwarding table
 - If router-id is the same, go to next step
 - If router-id is not the same, select the oldest path

BGP Path Selection Algorithm for Cisco IOS: Part Four

12. Lowest router-id (originator-id for reflected routes)
13. Shortest cluster-list
 - Client must be aware of Route Reflector attributes!
14. Lowest neighbour address

BGP Attributes and Path Selection



ISP Workshops